

SPECIFICATION COMPARISON



Number of effective pixels	102 million pixels	51.4 million pixels	51.4 million pixels
Image sensor	43.8mm×32.9mm Bayer array with primary color filter	43.8mm×32.9mm Bayer array with primary color filter	43.8mm×32.9mm Bayer array with primary color filter
File format	JPEG (Exif Ver.2.3) RAW : 14bit / 16bit RAW (RAF original format) 8-bit /16-bit(10-bit output in 16bit file) TIFF (In-camera Raw Conversion Only)	JPEG (Exif Ver.2.3) RAW : 14bit RAW (RAF original format), RAW+JPEG 8-bit TIFF (In-camera Raw Conversion Only)	JPEG (Exif Ver.2.3) RAW : 14bit RAW (RAF original format), RAW+JPEG 8-bit TIFF (In-camera Raw Conversion Only)
Number of recorded pixels	[L] <4:3> 11648×8736 [M] <4:3> 8256×6192 [S] <4:3> 4000×3000	[L] <4:3> 8256×6192 [S] <4:3> 4000×3000	[L] <4:3> 8256×6192 [S] <4:3> 4000×3000
Sensitivity	Standard Output AUTO1/AUTO2/AUTO3 (up to ISO12800) / ISO100–12800 (1/3 step) Extended Output ISO50 / 25600 / 51200 / 102400	Standard Output AUTO1/AUTO2/AUTO3 (up to ISO12800) / ISO100–12800 (1/3 step) Extended Output ISO50 / 25600 / 51200 / 102400	Standard Output AUTO1/AUTO2/AUTO3 (up to ISO12800) / ISO100–12800 (1/3 step) Extended Output ISO50 / 25600 / 51200 / 102400
Image Stabilizer	<input type="radio"/> Image sensor shift mechanism with 5-axis compensation 5.5 stops**2	<input type="radio"/> Supported with OIS type lenses	<input type="radio"/> Supported with OIS type lenses
Continuous shooting	CH Approx. 5.0fps, CL Approx. 2.0fps	Approx. 3.0fps	Approx. 3.0fps
AF Type	Intelligent Hybrid AF (TTL contrast AF / TTL phase detection AF)	TTL Contrast AF	TTL Contrast AF
LCD monitor	3.2 inch, Aspect Ratio 4:3, Approx. 2.36 million dots Tilt-Type (Three Direction), Touch Screen Color LCD Monitor	3.2 inch, Aspect Ratio 4:3, Approx. 2.36 million dots Tilt-Type (Three Direction), Touch Screen Color LCD Monitor	3.2 inch, Aspect Ratio 4:3, Approx. 2.36 million dots Tilt-Type (Two Direction), Touch Screen Color LCD Monitor
Sub LCD monitor	<input type="radio"/> 1.80 inch, Aspect Ratio 4:3, 303×230-dot Monochrome LCD Monitor	<input type="radio"/> 1.28 inch, Aspect Ratio 1:1, 128×128-dot Monochrome LCD Monitor	–
Rear sub monitor	<input type="radio"/> 2.05 inch, Aspect Ratio 4:1, 256×64-dot Monochrome OLED Monitor	–	–
Movie file format	MOV (MPEG-4 AVC / H.264, HEVC / H.265, Audio : Linear PCM / Stereo sound 24bit / 48KHz sampling)	MOV (MPEG-4 AVC / H.264, Audio : Linear PCM / Stereo sound 48KHz sampling)	MOV (MPEG-4 AVC / H.264, Audio : Linear PCM / Stereo sound 48KHz sampling)
Movie recording	[DCI4K / 4K] 29.97p / 25p / 24p / 23.98p, [Full HD] 59.94p / 50p / 29.97p / 25p / 24p / 23.98p	[Full HD] 29.97p / 25p / 24p / 23.98p [HD] 29.97p / 25p / 24p / 23.98p	[Full HD] 29.97p / 25p / 24p / 23.98p [HD] 29.97p / 25p / 24p / 23.98p
Wireless transmitter	IEEE802.11a/b/g/n/ac (standard wireless protocol)	IEEE 802.11b/g/n (standard wireless protocol)	IEEE 802.11b/g/n (standard wireless protocol)
Bluetooth®	Bluetooth Ver. 4.2 (Bluetooth low energy)	–	Bluetooth Ver. 4.2 (Bluetooth low energy)
Digital interface	USB Type-C (USB3.2 Gen1×1)	USB3.0 (High-Speed) / micro USB terminal	USB Type-C (USB3.1 Gen1)
HDMI output	HDMI Micro connector (Type D)	HDMI Micro connector (Type D)	HDMI Micro connector (Type D)
Other interface	ø3.5mm, stereo mini connector (Microphone) ø3.5mm, stereo mini connector (Headphone) ø2.5mm, Remote Release Connector DC IN 15V Connector *Compatible with AC-15V (Optional) Only Hot shoe Synchronized terminal	ø3.5mm, stereo mini connector (Microphone) ø3.5mm, stereo mini connector (Headphone) ø2.5mm, Remote Release Connector DC IN 15V Connector *Compatible with AC-15V (Optional) Only Hot shoe Synchronized terminal	ø2.5mm, Remote Release / Stereo Mini Connector (Microphone) DC IN 15V Connector *Compatible with AC-15V (Optional) Only Hot Shoe Synchronized Terminal
Power supply	NP-T125 (×2) Li-ion battery (included)	NP-T125 Li-ion battery (included)	NP-T125 Li-ion battery (included)
Battery life for still images	Approx. 800 frames.*2 (2 batteries installed, Auto power save ON)	Approx. 400 frames.*2 (Auto power save ON)	Approx. 400 frames.*2 (Auto power save ON)
USB power supply	<input type="radio"/> Support USB PD** (Power Delivery) power source to supply or rapidly recharge battery	–	–

*1 based on CIPA standard. Pitch / yaw shake only. *2 When GF63mmF2.8 R WR lens mounted. *3 USB PD Rev2.0 ver1.3

GFX100 MEMORY CARD CAPACITY AND IMAGE QUALITY / SIZE

Still Image	SDHC / SDXC memory card 8GB	SDHC / SDXC memory card 16GB	Movie** *5 *6	SDHC / SDXC memory card 8GB	SDHC / SDXC memory card 16GB
RAW	30	70	4K 3840×2160px 400Mbps	2min.	4min.
RAW (Lossless compressed)	70	140	Full HD 1920×1080px 200Mbps	4min.	10min.
L (4:3 / SUPER FINE)	120	260	*4 For recording movies, use a SD memory card with UHS Speed Class 3 or higher.		
L (4:3 / FINE)	190	390	*5 For recording movies in 400Mbps, use a SD memory card with Video Speed Class 60 or higher.		
L (4:3 / NORMAL)	300	630	*6 Recording movies in 400Mbps can be done with DCI4K / 4K 29.97p / 25p / 24p / 23.98p.		



[more info https://fujifilm-x.com/gfx100/](https://fujifilm-x.com/gfx100/)

To ensure correct usage, read owner's manual carefully before using your equipment.

All photos, illustrations, drawings and other images in this brochure are intended for illustrative purposes only.

SDXC logo is a trademark. All other trademarks are the property of their respective holders.

Specifications are subject to change without notice

For more information, please visit our website

**GFX
100**



PÁL
LAUKLI

GF100
GF110mmF2.8 LM WR
1/80s
F16
ISO100



PÁL
LAUKLI

GF100
GF110mmF2.8 LM WR
1/125s
F22
ISO100



MICHAEL
CLARK
GF1100
GF32-64mmF4 R LM WR
1/1600s
F5
ISO1250



PRESERVE FOR THE FUTURE

The GFX, FUJIFILM's mirrorless digital camera system, has achieved the highest level of image quality in the world of professional photography. The system continues its evolution...

GFX 100

The GFX100 uses large CMOS sensor with over 100 million pixels which makes this the highest class resolution mirrorless digital camera ever produced. The GFX100, is the coming together of FUJIFILM's unique blend of imaging and optical technologies and heralds the future of photography for the years to come.

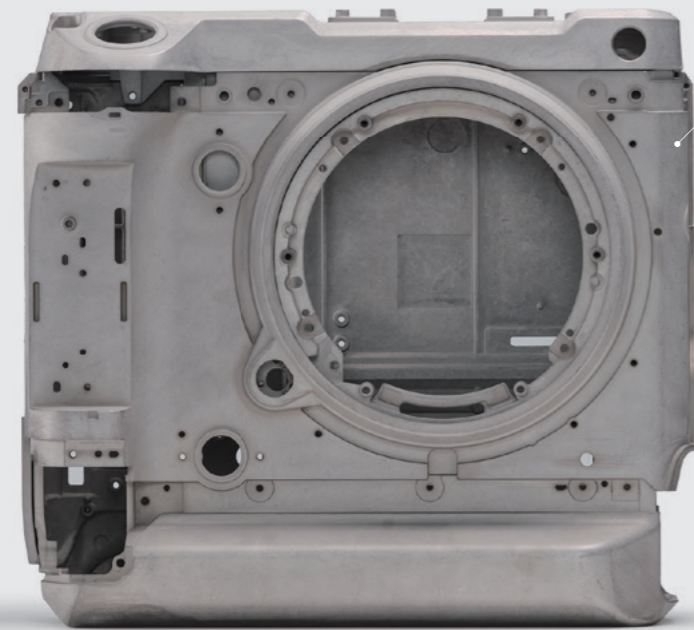

Magnesium Alloy Body



Dust-Resistant / Weather-Resistant

TOUGHNESS

Tough Body

The camera body is made of magnesium alloy, making it lightweight and very robust. The inner frame directly couples the sensor and IBIS unit with lens and lens mount to provide complete rigidity from the lens to the sensor. The engagement area between the front and rear panels has been maximized to achieve ultimate durability against external force.

Body Magnesium Alloy

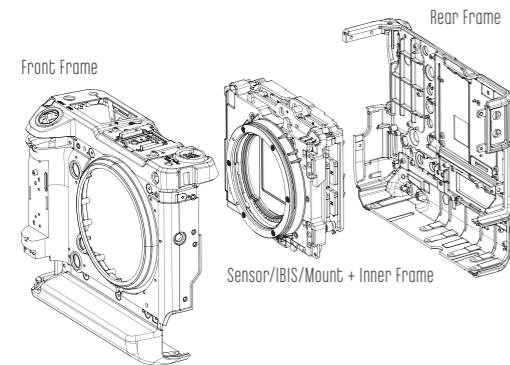

DUST-RESISTANT / WEATHER-RESISTANT

Body Resistance

The camera body is weather sealed at 95 points (including the electronic viewfinder) helping it withstand extreme conditions of dust, moisture and low temperatures. This means that the camera can comfortably handle a wide variety of shooting situations, be it shooting stills or video. This means the GFX100 is perfectly suited to being used in a studio but also outdoors in harsher environments.

Operating Condition

Temperature -10°C - 40°C / Humidity 10 - 80% (No condensation)

Dust-resistant Weather-resistant Sealing parts of body 76 / EVF 19



95 Sealing Parts

VERTICAL GRIP

Horizontal and Vertical Body Operation

The GFX100 camera body has a built in vertical grip, it is the first FUJIFILM camera to have this integrated grip design. This allows the camera to be thinner and lighter than before while still housing a large sensor, shutter mechanism, IBIS and two batteries. This balanced design of the camera allows the user to instantly switch from landscape to portrait orientation.

Dimensions Including EVF 156.2mm (W) × 163.6mm (H) × 102.9mm (D) (Minimum Depth : 48.9mm)

Excluding EVF 156.2mm (W) × 144.0mm (H) × 75.1mm (D) (Minimum Depth : 48.9mm)

Weight Approx. 1,400g (including EVF, battery x2 and memory card)
Approx. 1,320g (including battery x2 and memory card)
Approx. 1,155g (excluding accessories, battery and memory card)



BODY SURFACE

Texture and Operability

The magnesium alloy body, whilst lightweight and highly robust, is coated with premium colors and textures. The design and handling have been optimized based on feedback from professional photographers working in the fields of landscape, commercial and fashion portrait photography. The body has been designed down to the last detail, including the size and layout of buttons, dial designs, materials, and sounds.

Customizable Fn buttons Horizontal 8 buttons
Vertical 7 buttons

Touch Function 4 direction



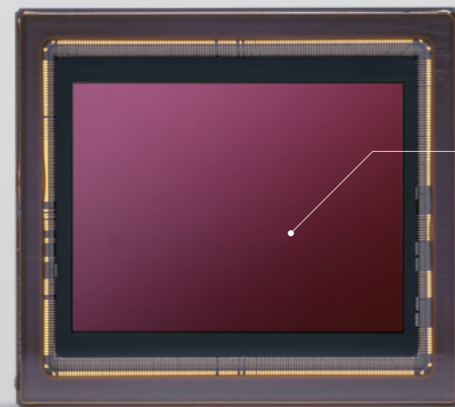

102 Megapixels Large CMOS Sensor

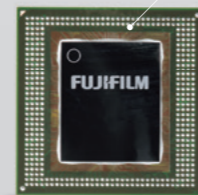

X-Processor 4



FUJIFILM G Mount

SENSOR

100MP+ Large CMOS sensor

The GFX Series' use of a large CMOS sensor (43.8×32.9mm) has paved the way for ultra high image resolution. The GFX100 delivers smooth gradation and image sharpness with the high resolution sensor. This is made possible thanks to FUJIFILM's expertise in medium format which has been gained since the days of film cameras. Experience the astonishing creative potential possible with the 100MP+ sensor.

Number of effective pixels 102 Million Pixels
Image sensor 43.8mm×32.9mm Bayer array with Primary Color Filter
 No Optical Low-Pass Filter
Number of Recorded Pixels [L] <4:3> 11648×8376
Sensitivity [Standard Output] AUTO1/AUTO2/AUTO3 (up to ISO12800) / ISO100-12800 (1/3 step)
 [Extended Output] ISO50 / 25600 / 51200 / 102400

Format size comparison

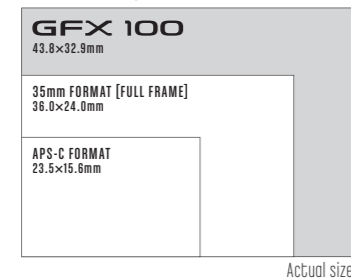

PROCESSOR

Image Processing Engine

The GFX100 uses the X-Processor 4, FUJIFILM's latest image processing engine to quickly optimize the data from the high resolution image sensor. Despite the massive amount of data involved, the processor handles it at a speed. You can also apply the Film Simulation modes to 100MP+ image data to achieve FUJIFILM's unique styles of color and tone reproduction.

Startup time 0.4sec.
Maximum continuous shooting speed 5.0Pps*1
EVF refresh rate Approx. 85Pps*2
 *1 When using the mechanical shutter in CH mode.
 *2 When using the BOOST mode with FRAME RATE PRIORITY.

MOUNT

FUJIFILM G Mount

The G Mount, was designed to accommodate GF lenses with 100MP+ sensors in mind. Taking maximum advantage of the mirrorless system, the G Mount has a short flange focal distance which contributes to the camera's compact form and mirrors GF lenses' design and advanced performance. When combined with a large CMOS sensor, the system prevents peripheral light fall-off to achieve stunning edge to edge sharpness.

Electronic Contact 12 pins
Sensor Cleaning Ultra Sonic Vibration

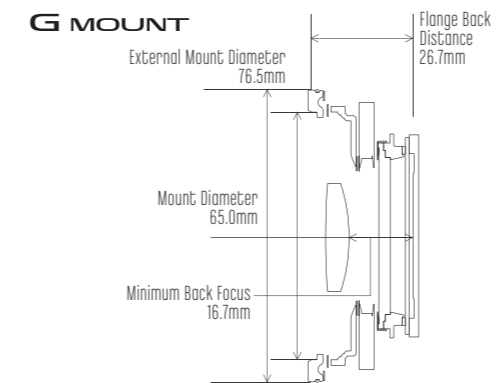

FORMAT / ASPECT

Image Format, Size and Aspect

The GFX100 allows users to capture images in various formats and image qualities. This includes uncompressed / lossless compressed RAW and JPEG formats of varying image sizes, aspect ratios and compression ratios. Its in camera RAW processing gives the option of saving 8bit or 10bit color depth images as 8bit or 16bit TIFF files. When using a 35mm format lens via a mount adapter, the camera can record images in a 36.0mm×24.0mm frame at the center (60.8M) as JPEG or TIFF (in camera RAW processing) formats.

Electronic Contact ExiP Ver.2.3
RAW 14-bit / 16-bit RAW (RAF original Format)
RAW+JPEG
TIFF 8-bit / 16-bit (10-bit output save as 16-bit)
 *In-camera Raw Conversion Only

4:3 [L] 11648×8376 [M] 8256×6192 [S] 4000×3000	5:4 [L] 10928×8736 [M] 7744×6192 [S] 3744×3000	35mm FORMAT (3:2) [L] 9552×6388
3:2 [L] 11648×7768 [M] 8256×5504 [S] 4000×2664	7:6 [L] 10192×8736 [M] 7232×6192 [S] 3504×3000	1:1 [L] 8736×8736 [M] 6192×6192 [S] 2992×2992
16:9 [L] 11648×6552 [M] 8256×4840 [S] 4000×2248	65:24 [L] 11648×4304 [S] 4000×1480 [M] 8256×3048	

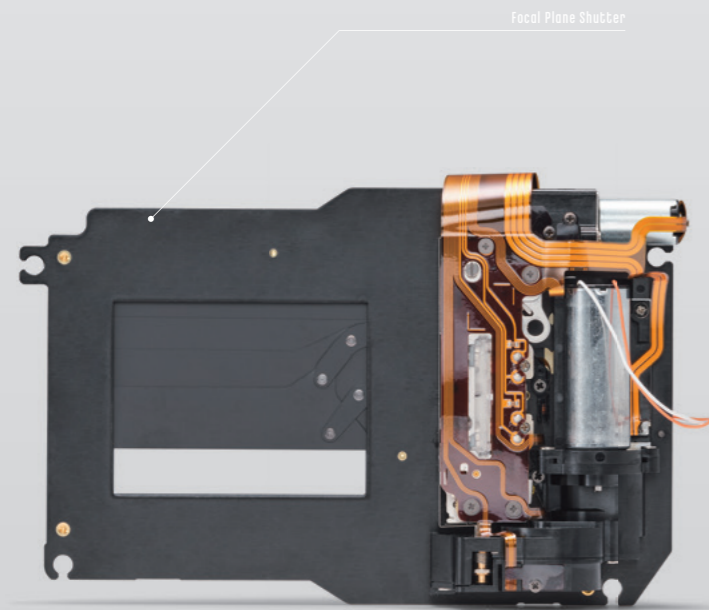

Focal Plane Shutter

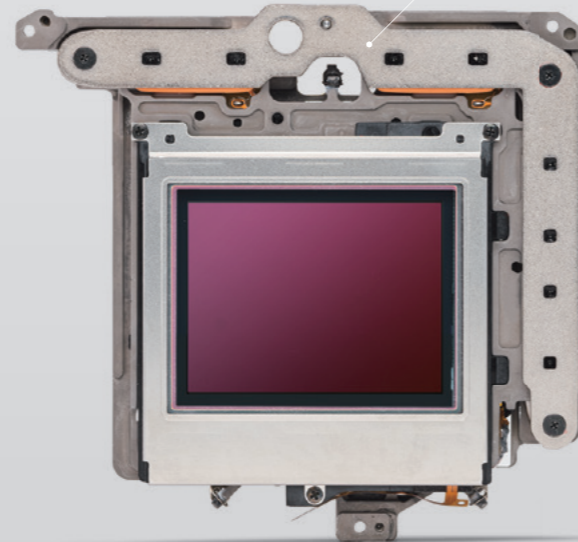

IBIS Unit



Grip

SHUTTER

Focal Plane Shutter

The GFX focal plane shutter is specifically designed for large CMOS sensor, mirrorless digital cameras. With a durability performance of over 150,000 shutter actuations*1, it combines an electronic front curtain shutter with an exceptionally quiet mechanical shutter which has a maximum speed of 1/4000sec. The shutter system has been redesigned for the GFX100 to support the new large CMOS sensor with continuous shooting of up to 5.0fps. You can select from three types of shutters, including an electronic shutter, according to your shooting conditions.

Mechanical Shutter

P mode: 4sec. to 1/4000sec. A mode: 30sec. to 1/4000sec.
S/M mode: 60min. to 1/4000sec. Bulb mode: up to 60min.

Electronic Shutter*2

P mode: 4sec. to 1/16000sec. A mode: 30sec. to 1/16000sec.
S/M mode: 60min. to 1/16000sec. Bulb mode: up to 60min.

Electronic Front Curtain Shutter*3

P mode: 4sec. to 1/4000sec. A mode: 30sec. to 1/4000sec.
S/M mode: 60min. to 1/4000sec. Bulb mode: up to 60min.

Mechanical + Electronic Shutter*2

P mode: 4sec. to 1/16000sec. A mode: 30sec. to 1/16000sec.
S/M mode: 60min. to 1/16000sec. Bulb mode: up to 60min.

Electronic Front Curtain Shutter + Electronic Shutter*2*3

P mode: 4sec. to 1/16000sec. A mode: 30sec. to 1/16000sec.
S/M mode: 60min. to 1/16000sec. Bulb mode: up to 60min.

Synchronized shutter speed for flash

1/125sec. or slower

*1 According to Fujifilm internal testing. *2 The Electronic Shutter may not be suitable for fast-moving objects or hand-held shooting. Flash can not be used. *3 When using the electronic front-curtain shutter, the continuous shooting speed supports CL only, and using a high-speed shutter, the shutter switches to mechanical shutter. (Faster than 1/1250sec. to 1/4000sec.)

IMAGE STABILIZATION

In Body Image Stabilization

The GFX100 is a first mirrorless digital camera equipped with an in-body image stabilization (IBIS) mechanism for a large CMOS sensor in GFX series. It provides precision control for the high definition images produced by the camera's large size CMOS sensor, which is approx. 1.7 times the size of a 35mm format sensor. This feature revolutionizes the large CMOS sensor camera system, unleashing its advanced performance with greater flexibility in a wider variety of shooting conditions.

Specification three axis accelerometer, three axis gyro sensor, dedicated dual processor

Image stabilizer mechanism Image sensor shift mechanism with 5-axis compensation

Compensation Effect 5.5 stops*4

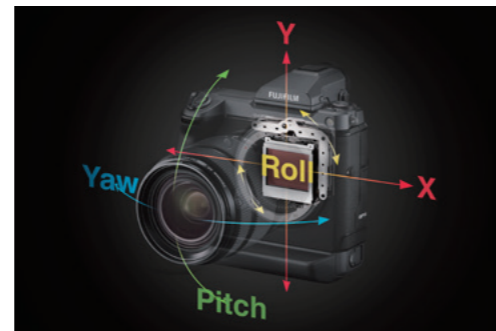

*4 Based on CIPA standard. Pitch / yaw shake only. With GF63mmF2.8 R WR lens mounted.

SHOCK ABSORBER

Shock Absorption Mechanism For the Shutter

The GFX100's shutter has a shock absorption mechanism ideal for landscape photography, studio shooting and commercial photography, all of which are unforgiving to even the slightest of camera shakes. The shutter unit is suspended at the top, bottom, right and left and is able to absorb subtle shakes caused when the mechanical shutter is used. It also enables quicker shutter response, which is useful in a variety of shooting situations.



Suspended at the top, bottom, right and left side of the shutter

GRIP

Ergonomic Grip

The in body image stabilization (IBIS) and the shutter's shock absorbing structure are complemented by the grip design, which is shaped to provide added stability for hand held shooting in various conditions. It allows you to hold the camera firm and there is a better balance even when a large lens is mounted, so that you can focus on the composition of your shake free images.





ELECTRONIC VIEW FINDER

High Magnification and High Definition Electronic Viewfinder

The GFX100 comes with a detachable 5.76M dot EVF with approx. 100% coverage. Resolution priority, frame rate priority and AF priority can be selected in boost mode for live view depending on the subject.

Finder

0.5 inch Approx. 5.76 million dots OLED Color Viewfinder
Coverage of Viewing Area vs. Capturing Area: Approx. 100%

Eyepoint Approx. 23mm (From the Rear End of the Camera's Eyepiece)

Diopter Adjustment -4 - +2m⁻¹

Magnification

0.86x with 50mm Lens (35mm Equivalent) at infinity and Diopter set to -1.0m⁻¹

Diagonal Angle of View Approx. 41° (Horizontal Angle of View: Approx. 33°)

EVF Brightness AUTO / -7 - +5 (50 - 800cd/m²)

EVF Color -5 - +5

EVF Color Adjustment [R] -5 - +5 [B] -5 - +5

Others Built-In Eye Sensor

EVF TILTING ADAPTER

EVF-TL1 Optional

Attach the optional EVF Tilting Adapter EVF-TL1 between the camera body and the EVF will enable vertical tilt (0°-90° / 5 steps) and horizontal rotation (±45°). This allows you to shoot from waist level or aids shooting in portrait orientation.



REAR SUB MONITOR

Rear Customizable Information Monitor

The rear panel features a sub monitor, which can be configured to display various data previously displayed on the main LCD monitor. Minimizing the amount of data that has to be displayed on the main LCD monitor makes it easy to check the overall framing and concentrate on the composition. You can choose to display the exposure compensation gauge and histogram on the sub monitor to enable exposure adjustment whilst checking the exposure level.

Size 2.05 inch

Number of dots 256x64-dot

Type Monochrome OLED Monitor

Aspect Ratio 4:1

Menu Setting Information 1, Information 2, Scale, Histogram



Information 1

Information 2



Scale

Histogram

SUB MONITOR

Multi Function Monitor

The top panel features a clear, 1.8-inch B/W sub LCD monitor that displays the main shooting settings such as shutter speed, aperture, ISO sensitivity and exposure compensation, as well as function icons, remaining number of frames (stills) and remaining filming time (video). This display can be configured according to what information you want to be displayed. When you switch between stills and video modes, all the settings shown on this sub monitor also change accordingly, ensuring that all relevant data is available at hand.

Size 1.80 inch

Number of dots 303x230-dot

Type Monochrome LCD Monitor

Aspect Ratio 4:3



Information (Still)

Information (Movie)

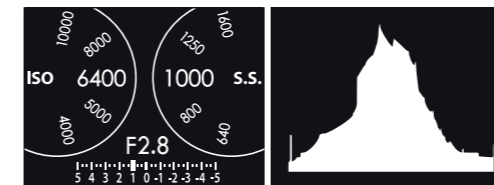

Dials

Histogram

MAIN MONITOR

3.2inch Tilting LCD Screen

The rear panel features the main 3.2-inch 2.36 million dot LCD monitor that has 100% coverage and tilts in three directions, 90 degrees upward, 45 degrees downward and 60 degrees to the right. The use of capacitive touchscreen panel allows easier shooting in high and low angles, which can be difficult when using the EVF.

Monitor

3.2 inch, Aspect Ratio 4:3, Approx. 2,360K-dot Tilt-Type, Touch Screen
Color LCD Monitor (Approx. 100% Coverage)

Tilting Direction Three directions

LCD Brightness -5 - +5 (30 - 800cd/m²)

LCD Color -5 - +5

LCD Color Adjustment [R] -5 - +5 [B] -5 - +5





Medium Format Film



FILM SIMULATION

FUJIFILM's Original Color Reproduction

As a manufacturer of cameras and photographic films for many years, FUJIFILM has developed the Film Simulation modes to digitally replicate the look of film. The GFX100 allows users reproduce these colors and tones, despite its large image resolution, adding an artistic flair to images with exceptional quality.

PROVIA / Standard	Standard mode For general use that faithfully reproduces colors just as you remember them.	ETERNA / CINEMA	Soft color and rich shadow tone suitable for a movie film look.
Velvia / Vivid	A combination of high saturation and natural colors, this option reproduces vivid colors ideal for landscapes.	ACROS	Premium monochrome mode delivers fine texture, deep blacks and smoother tones.
ASTIA / Soft	Combining a soft effect with high saturation, this option delivers radiant skin tones and smooth gradation.	MONOCHROME	General use monochrome mode that offers three filter options (Ye, R and G), just like ACROS.
CLASSIC CHROME	Delivering subtle colors and beautifully muted tones, this simulation is reminiscent of vintage reversal film.	SEPIA	Adds a warm tone across the frame for a sepia look. When applied to a retro subject, it creates a nostalgic look.
PRO Neg. Hi	Produce portraits with sharp contrast even in flat light. This option delivers preferable natural skin tones.		
PRO Neg. Std	Reproduces accurate, natural skin tones in portraits shot under controlled light.		



PRO Neg. Std



ACROS



Velvia

IMAGE SETTINGS

Effects

The GFX100 offers additional photographic effects including the "Grain Effect" for replicating the graininess of analogue photos, the "Color Chrome Effect" for adding deeper tonal gradation to a subject matter with highly saturated colors, and the "Smooth Skin Effect," a new function developed for the GFX100 for smoothing the skin tones for use in portrait photography.

GRAIN EFFECT OFF / Weak / Strong
COLOR CHROME EFFECT OFF / Weak / Strong
SMOOTH SKIN EFFECT OFF / Weak / Strong

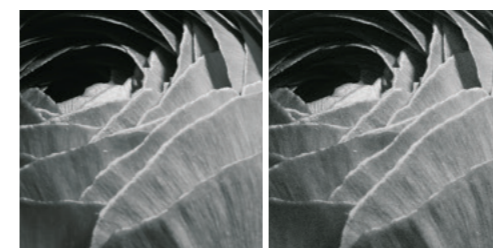

GRAIN EFFECT: OFF

GRAIN EFFECT: Strong

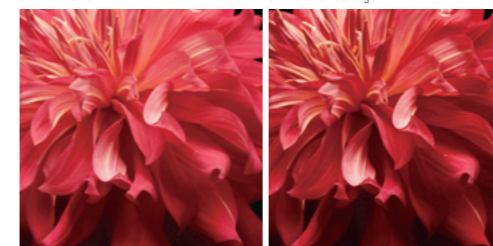

COLOR CHROME EFFECT: OFF

COLOR CHROME EFFECT: Strong

WHITE BALANCE

White Balance Adjustment

You can choose the white balance setting from Auto, Custom, Color Temperature and Preset. The white balance can be fine tuned in the WB Shift feature with RB color coordinates. In the Custom mode, which measures the ambient light to determine white balance, you can also adjust size and location settings and register three presets.

Mode Automatic Scene Recognition

Color Temperature Selection 2500K - 10000K

Custom Custom 1-3 Size / Area Selectable

Preset Daylight, Shade, Fluorescent Light (Daylight), Fluorescent Light (Warm White), Fluorescent Light (Cool White), Incandescent Light, Underwater



2500K

5000K

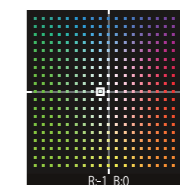

R-B G-B

White Balance Shift

Movie Mode

Headphone Connector

USB-C Port

4K HDMI Output



MOVIE RECORDING

4K Movie / 10bit Color Depth

The full potential of the large CMOS sensor in the GFX can be seen when shooting both stills and video. The combination of the latest sensor and the "X-Processor 4" enables support for 4K/30P video. The camera's sensor, which is larger than that of most cinema cameras, produces a shallow depth of field, enhanced tonal gradient in 10-bit output, and greater ISO sensitivity. The format size produces video footage with more detailed textures while reproducing three dimensional definitions. You are able to capture the atmosphere of the scene unlike anything before. All the Film Simulation modes can be applied to video as well, including "Eterna," which replicates the look of FUJIFILM's cinema film of the same name. Furthermore, the camera supports the digital cinema aspect ratio (17:9), compression codecs such as H.265 and H.264, and a bit rate of up to 400Mbps.

Setting (Size)	Movie Compression	Frame rate	Codec / YUV / Bit depth	Bit rate	Shutter Speed
DCI4K 17:9 (4096x2160)	All-Intra	29.97p 24.00p	H.265 (HEVC) / 4:2:0 / 10bit H.264 / 4:2:0 / 8bit	400Mbps	1/4000-1/4sec.
	Long-GOP	29.97p 24.00p	H.265 (HEVC) / 4:2:0 / 10bit H.264 / 4:2:0 / 8bit	400Mbps 200Mbps 100Mbps	1/4000-1/24sec.*2
	Uncompressed (HDMI Output)	29.97p 24.00p	— *1 / 4:2:2 / 10bit	— *1	1/4000-1/4sec.
FHD 17:9 (2048x1080)	All-Intra	59.94p 29.97p 24.00p	H.265 (HEVC) / 4:2:0 / 10bit H.264 / 4:2:0 / 8bit	200Mbps	1/4000-1/4sec.
	Long-GOP	59.94p 29.97p 24.00p	H.265 (HEVC) / 4:2:0 / 10bit H.264 / 4:2:0 / 8bit	200Mbps 100Mbps 50Mbps	1/4000-1/24sec.*2
	Uncompressed (HDMI Output)	59.94p 29.97p 24.00p	— *1 / 4:2:2 / 10bit	— *1	1/4000-1/4sec.
FHD 16:9 (1920x1080)	All-Intra	59.94p 29.97p 24.00p	H.265 (HEVC) / 4:2:0 / 10bit H.264 / 4:2:0 / 8bit	200Mbps	1/4000-1/4sec.
	Long-GOP	59.94p 29.97p 24.00p	H.265 (HEVC) / 4:2:0 / 10bit H.264 / 4:2:0 / 8bit	200Mbps 100Mbps 50Mbps	1/4000-1/24sec.*2
	Uncompressed (HDMI Output)	59.94p 29.97p 24.00p	— *1 / 4:2:2 / 10bit	— *1	1/4000-1/4sec.

*1 Codec and bit rate will be changed depends on the recorder. *2 Cannot choose slower shutter speed than Frame rate.

MOVIE FORMAT

Movie Recording

With its large CMOS sensor, the GFX100 demonstrates its appeal in video recording. It uses full sensor width to record video in 4K digital cinema format in the aspect ratios of 16:9 / 17:9. The sensor area used is greater than that of most cinema cameras that support a large format sensor. You can use GF lenses and adaptors to achieve a variety of videographic expressions that only large sensors can deliver, and record them in high resolution 4K video.

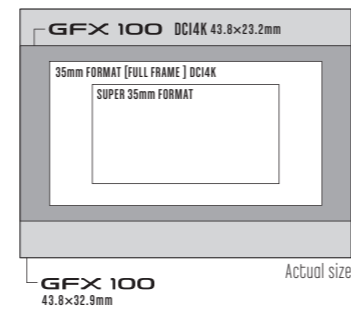

OUTPUT

Simultaneous Output to HDMI and SD card

The high speed processing engine, X-Processor 4, can read and output condensed video data, feeding 4K/30P 4:2:2 10bit data to the HDMI port and recording 4K/30P 4:2:0 10bit data to an SD card (when H.265 is selected) up to 400Mbps*3. You can also choose All-Intra*4 / Long-GOP, etc. The processor's enhanced capability means video footage can be viewed on the camera's LCD screen as well as on an external monitor whilst you film, while feeding uncompressed data straight to a recorder.



*3 Available at: 4K/29.97P, 25P, 24P or 23.98P. Requires an SD card with the video speed class of V60 or above to record at the bit rate of 400Mbps. *4 Available at: 4K/29.97P, 25P, 24P, 23.98P, and FHD/59.94P, 50P, 29.97P, 25P, 24P, 23.98P when H.265/HEVC is selected. Not compatible with H.264.

COLOR GRADING

F-Log / HLG Support

The GFX100 is capable of recording F-Log, characterized by a gamma curve with a wide dynamic range, and capturing video in HLG (Hybrid Log Gamma), one of the formats defined in the ITU-R BT.2100 international standards. Coupled with color information attained in 10-bit color depth, the camera records premium quality footage faithfully depicting scenes even with a large brightness range or subjects with high color saturation.



RUSSEL
ORD
GFX100
GF250mmF4 R LM OIS WR + GF1.4XC WR
1/1600s
F5.6
ISO200

AUTO FOCUS

Phase Detection AF System

The GFX100 is the first GFX that features a phase detection AF system on large CMOS sensor. The GFX100 has phase detection pixels across the entire sensor and using the X-Processor 4 engine coupled with the latest AF algorithm, is able to focus on a subject at high speed with accuracy even when the subject is away from the center of the frame or in low light.



FOCUS MODES

Six AF Modes and AF-C Customization

The GFX100 has six AF modes that cater for all types of subject movement. The AF-S locks focus while the AF-C focuses continuously on a moving subject. These can be combined with focus area options, namely "Single Point," "Zone" and "Wide / Tracking." You can also keep six custom settings for AF-C to adjust "Tracking Sensitivity", "Speed Tracking Sensitivity" and "Zone Area Switching" according to the characteristics of subject movement.

AF Modes

- AF-S + Single Point** For capturing subjects using a specific AF point
- AF-S + Zone** For capturing subjects across a large AF area
- AF-S + Wide** For automatically capturing a subject across the Frame
- AF-C + Single Point** For continuous spot-Focusing
- AF-C + Zone** For tracking a subject within a selected area
- AF-C + Tracking** For continuously tracking a subject across the Frame

AF-C Custom Setting

- SET 1** Multi purpose
- SET 2** Ignoring obstacles
- SET 3** Accelerating / decelerating subjects
- SET 4** Subjects that suddenly come into the Frame
- SET 5** Erratically moving
- SET 6** Custom

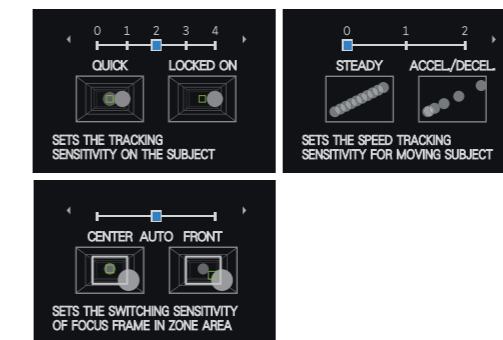

FACE DETECTION / EYE DETECTION

Face/Eye Tracking and Auto Focus

Using the new sensor in conjunction with the X-Processor 4, gives an advanced level of face tracking performance. The photographer has the ability to identify and capture even easier than before, difficult subjects like a person inside profile. In the Eye AF mode, you can even specify which of the subject's eyes you want the camera to prioritize. This is particularly useful in portraiture, which commands focusing accuracy with a very shallow depth of field. The touchscreen panel or Focus Lever can be used to select which of a crowd of faces detected you want the camera to track, focus and adjust exposure to.

Face / Eye Detection Setting ON (EYE OFF, EYE AUTO, RIGHT EYE PRIORITY, LEFT EYE PRIORITY) / OFF

Face Select Touch Panel / Function (Fn) setting

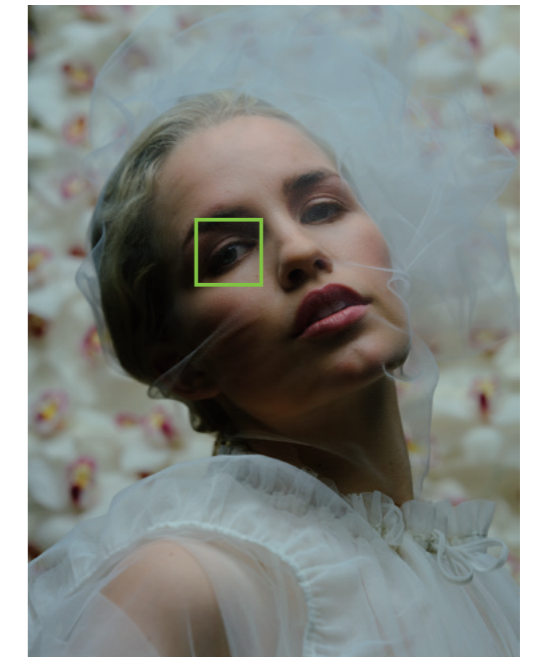

FEATHER TOUCH SHUTTER

Leaf Spring Switch Shutter

The GFX100 is equipped with a feather touch shutter button that responds to delicate shutter release actions. The button reacts to the subtlest movements of the finger when gripping the camera body firmly in both portrait and landscape orientations. The use of the electronic front curtain shutter minimizes release time lag to give even greater confidence in shutter operation.

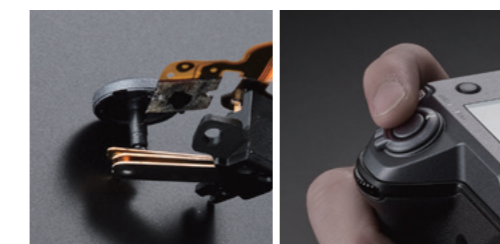

CONTINUOUS SHOOTING

Burst mode

Continuous shooting is available in two frame rates, i.e. high speed burst at 5.0fps (CH) and low speed burst at 2.0fps, which can be checked in Live View*. When the AF-C is selected, the GFX100 combines it with various phase detection AF modes and face detection to shoot in bursts while tracking and focusing on a moving subject.

CH Approx. 5.0Fps (JPEG: 41 Frames Lossless compression RAW: 14 Frames Uncompressed RAW: 13 Frames)

CL Approx. 2.0Fps (JPEG: Endless Lossless compression RAW: 20 Frames Uncompressed RAW: 15 Frames)

*When Using the Electronic Shutter CH continuous shooting speed drops to approx. 2.9fps.

*Electronic Front Curtain Shutter support CL only.

*Recordable Frame depends on recording media.

*Speed of P continuous shooting depends on shooting environment and shooting Frames.

EXPOSURE MODE

Switch P / S / A / M Mode

The shooting mode button (Fn2) on the top panel allows you to switch between "Program (P)" and "Shutter Speed Priority (S)" (when the aperture is set to Auto) and between "Aperture Priority (A)" and "Manual (M)" (when the aperture is set to Manual). These selections can be assigned to a function button of your choice in Function (Fn) Setting.



Shooting mode button

DRIVE MODE DIAL

Still / Multi / Movie mode switch

Rotate the Drive Mode Dial to switch between the Still, Multi and Video modes. Selecting the Still or Video mode restores the respective settings so that you can start shooting as soon as you switch, without having to adjust settings. The Drive Button allows you to adjust burst speed and video frame rate. The Dial Lock Release Button prevents any accidental use.



INFORMATION DISPLAY

3D Electronic Level / Histogram

The electronic level uses a 3D system which is highly effective for architecture or landscape photography, when the accuracy of horizontal and vertical lines is crucial. Four types of histogram can be displayed: RGB and brightness, each with or without highlight warnings.



BRACKETING

Six Types of Bracketing

Six types of bracketing are available to capture multiple frames at different settings with a single press of the shutter release. This function works with both JPEG and RAW formats.

AE Bracketing Frames: -2, -3, +3, +2, ±9, ±7, ±5, ±3
±1/3EV - ±3EV, 1/3EV step

Film Simulation Bracketing Any 3 Types of Film Simulation Selectable

Dynamic Range Bracketing 100% - 200% - 400%

ISO Sensitivity Bracketing ±1/3EV / ±2/3EV / ±1EV

White Balance Bracketing ±1 / ±2 / ±3

Focus Bracketing Interval, Number of shots, 10 step

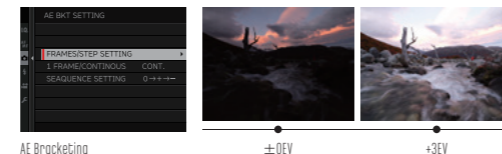

AE Bracketing

-0.5EV

+3EV

CUSTOMISABLE CONTROL

Buttons / Menu Customization

Numerous function (Fn) buttons are provided on the camera body allowing you to assign your preferred settings for easier operation. The 16 items shown in the Q (Quick) menu and C1 - C7 can also be reconfigured to instantly access your favorite Film Simulation modes or image quality settings. The camera also supports "My Menu," where your most frequently-used items can be stored.

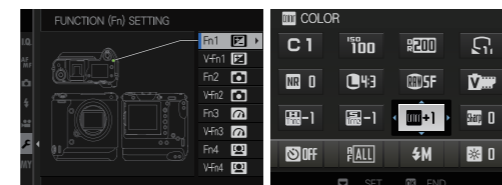

BATTERY MANAGEMENT

Battery Age

Check the age of the batteries in the camera. Battery age is expressed as a number between 0 (youngest) and 4 (oldest).

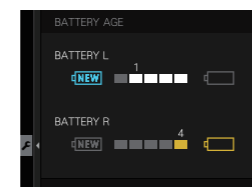

PHOTOMETRY

Four Metering Modes

The GFX100 offers four metering modes: multi metering, spot metering, average metering and center-weighted metering. When using the spot metering mode, the selected focus area is also used for metering. The options allow you to adjust metering according to the surrounding environment or your subject matter.

Multi Calculates exposure based on an analysis of the whole frame

Spot Takes a meter reading from an area occupying approx. 2% of the frame

Average Sets exposure based on the average brightness of the entire frame

Centre Weighted Takes a meter reading mainly from the center of the frame

CONNECTIVITY

Wireless Communication and Pairing

Install the free application "FUJIFILM Camera Remote" on your smartphone or tablet device to shoot via Live View and transfer your camera images to your device. The camera can also be paired with your device via Bluetooth® to automatically transfer images. Using the app you can also update the camera firmware directly.



Enable to download : <http://app.fujifilm-dsc.com/>

EXIF / VOICE MEMO

Copyright Data For EXIF

Use the touchscreen panel to enter "Author" and "Copyright" to your file's EXIF data.

Voice Memo Function

Record your voice for up to 30 seconds to make notes about the images you are shooting to keep track of your shoots.

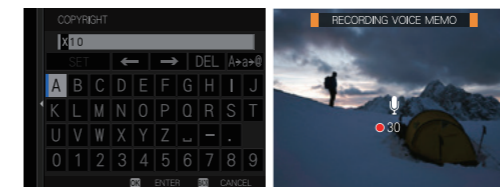

SENSITIVITY

ISO Sensitivity

The standard ISO sensitivity range is ISO100-12800, with extended sensitivities of ISO50, ISO25600, ISO51200 and ISO102400. RAW format is supported at all ISO settings. The AUTO function allows you to set the standard ISO, low shutter speed limit and upper ISO limit, and configure AUTO 1 - 3 settings according to shooting conditions.

Still

Standard Output AUTO1 / AUTO2 / AUTO3 (up to ISO12800) / ISO100 to 12800 (1/3 step)

Extended Output ISO50 / 25600 / 51200 / 102400

Movie

Standard Output AUTO (up to ISO12800) / ISO100 to 12800 (1/3 step)

Extended Output ISO25600

INTERVAL / SELF TIMER

Time-lapse shooting

Sample unique shooting styles including fixed point photography, time lapse and self timer images with controls over shooting interval, total number of frames and shutter delay. The Self Timer function can be set to 2 sec. or 10 sec. The former is particularly useful for situations when you want to minimize camera shake, such as long exposures.

Shooting Interval 1sec. - 24 hours

Number of Frames 1 - 999 + ∞

Shutter Delay In 0min. - 24 hours

STANDBY MODE

Shooting Standby Mode

In standby mode, all displays except the Sub LCD Monitor and Rear Sub Monitor turn off to save power when the camera is not in use. Choose the length of time your camera will wait before entering standby mode: 5min., 2min., 1min., 30sec., or 15sec.

Standby Mode 5min, 2min, 1min, 30sec., or 15sec.

USB CHARGE

Powering the Camera or Recharging via the USB

The GFX100 can be powered and recharged via the USB-C port, enabling extended shooting and removing any worries about running out of power. While traveling to a shoot or when on an outdoor shoot, you can use a USB PD(Power Delivery) power source which can power the camera or rapidly recharge the battery. If you use device with over 30W delivery, you can charge two batteries simultaneously and quickly.

USB PD Rev2.0 ver1.3



JAN
GONZALES

GFX100
GF120mmF4 R LM OIS WR Macro
1/125s
F8
ISO100



ERIC
MARO

GFX100
GF110mmF2 R LM WR
1/125s
F11
ISO100

FEEL THE DETAIL

The GFX100 is complimented by an expansive range of lenses and accessories to maximize your workflow. When mounted on the GFX100, the GF Series of lenses, capture detail only a large CMOS sensor can see. You have a sense of dynamic presence, 3D definition and atmosphere unlike any other format. In addition to GF lenses, the GFX camera system can deliver the full performance potential of classic lenses built for medium format or large format cameras.

GF LENS



GF LENS

prime lens

- Super ED Lens
- ED Lens
- Aspherical Lens

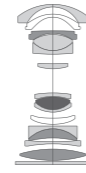

GF23mmF4 R LM WR

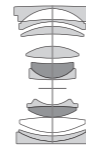

GF45mmF2.8 R WR



GF50mmF3.5 R LM WR



GF63mmF2.8 R WR

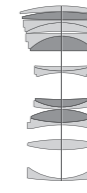

GF110mmF2 R LM WR

Lens configuration	15 elements in 12 groups (includes 2 aspherical, 3 ED and 1 super ED elements)	11 elements in 8 groups (includes 1 aspherical and 2 ED elements)	9 elements in 6 groups (includes 1 aspherical element)	10 elements in 8 groups (includes 1 ED element)	14 elements in 9 groups (includes 4 ED elements)
Focal length <small>(35mm Format equivalent)</small>	F=23mm (18mm)	F=45mm (36mm)	F=50mm (40mm)	F=63mm (50mm)	F=110mm (87mm)
Angle of view	99.9°	62.6°	57.4°	46.9°	27.9°
Max. aperture	F4	F2.8	F3.5	F2.8	F2
Min. aperture	F32	F32	F32	F32	F22
Aperture control	9 (rounded diaphragm opening)	9 (rounded diaphragm opening)	9 (rounded diaphragm opening)	9 (rounded diaphragm opening)	9 (rounded diaphragm opening)
Number of blades	9 (rounded diaphragm opening)	9 (rounded diaphragm opening)	9 (rounded diaphragm opening)	9 (rounded diaphragm opening)	9 (rounded diaphragm opening)
Step size	1/3EV (19 steps)	1/3EV (22 steps)	1/3EV (20 steps)	1/3EV (22 steps)	1/3EV (22 steps)
Focus range	38cm - ∞	45cm - ∞	0.55m - ∞	0.5m - ∞	0.9m - ∞
Max. magnification	0.09x	0.14x	0.1x	0.17x	0.16x
Dimensions <small>*distance From camera lens mount flange</small>	approx. ø89.8mm×103mm	approx. ø84mm×88mm	approx. ø84mm×48mm	approx. ø84mm×71mm	approx. ø94.3mm×125.5mm
Weight <small>*excluding caps,hoods and Tripod collar Foot</small>	approx. 845g	approx. 490g	approx. 335g	approx. 405g	approx. 1,010g
Filter size	ø82mm	ø62mm	ø62mm	ø62mm	ø77mm

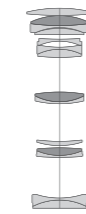

GF120mmF4 R LM OIS WR Macro



GF250mmF4 R LM OIS WR

zoom lens

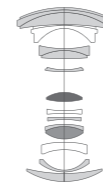

GF32-64mmF4 R LM WR

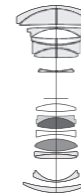

GF45-100mmF4 R LM OIS WR

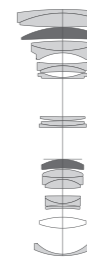

GF100-200mmF5.6 R LM OIS WR

teleconverter



GF1.4X TC WR

Lens configuration	14 elements in 9 groups (includes 3 ED elements)	16 elements in 10 groups (includes 2 ED and 1 super ED elements)	14 elements in 11 groups (includes 3 aspherical, 1 ED and 1 super ED elements)	16 elements in 12 groups (includes 3 aspherical, 1 ED and 1 super ED elements)	20 elements in 13 groups (includes 1 aspherical and 2 super ED elements)	7 elements 3 groups
Focal length <small>(35mm Format equivalent)</small>	F=120mm (95mm)	F=250mm (198mm)	F=32-64mm (25-51mm)	F=45-100mm (36-79mm)	F=100-200mm (79-158mm)	1.4x that of original lens
Angle of view	25.7°	12.5°	81°-46.3°	62.6°-30.6°	30.6°-15.6°	
Max. aperture	F4	F4	F4	F4	F5.6	1 additional stop
Min. aperture	F32	F32	F32	F32	F32	1 additional stop
Aperture control	9 (rounded diaphragm opening)	9 (rounded diaphragm opening)	9 (rounded diaphragm opening)	9 (rounded diaphragm opening)	9 (rounded diaphragm opening)	
Number of blades	9 (rounded diaphragm opening)	9 (rounded diaphragm opening)	9 (rounded diaphragm opening)	9 (rounded diaphragm opening)	9 (rounded diaphragm opening)	
Step size	1/3EV (19 steps)	1/3EV (19 steps)	1/3EV (19 steps)	1/3EV (19 steps)	1/3EV (16 steps)	
Focus range	45cm - ∞	1.4m - ∞	[Wide] 0.5m - ∞ / [Telephoto] 0.6m - ∞	[Wide] 0.65m - ∞ / [Telephoto] 0.82m - ∞	[Wide] 0.6m - ∞ / [Telephoto] 1.2m - ∞	Approx. same as that of original lens
Max. magnification	0.5x	0.22x	0.12x [T]	0.13x [T]	0.2x [W]	1.4x that of original lens
Dimensions <small>*distance From camera lens mount flange</small>	approx. ø89.2mm×152.5mm	approx. ø108mm×203.5mm	approx. ø92.6mm×116mm (Wide) / 145.5mm (Telephoto)	approx. ø93mm×144.5mm (Wide) / 174.5mm (Telephoto)	approx. ø89.5mm×183mm	approx. ø82×26.7mm
Weight <small>*excluding caps,hoods and Tripod collar Foot</small>	approx. 980g	approx. 1,425g	approx. 875g	approx. 1,005g	approx. 1,050g	approx. 400g
Filter size	ø72mm	ø82mm	ø77mm	ø82mm	ø77mm	



EF-X500

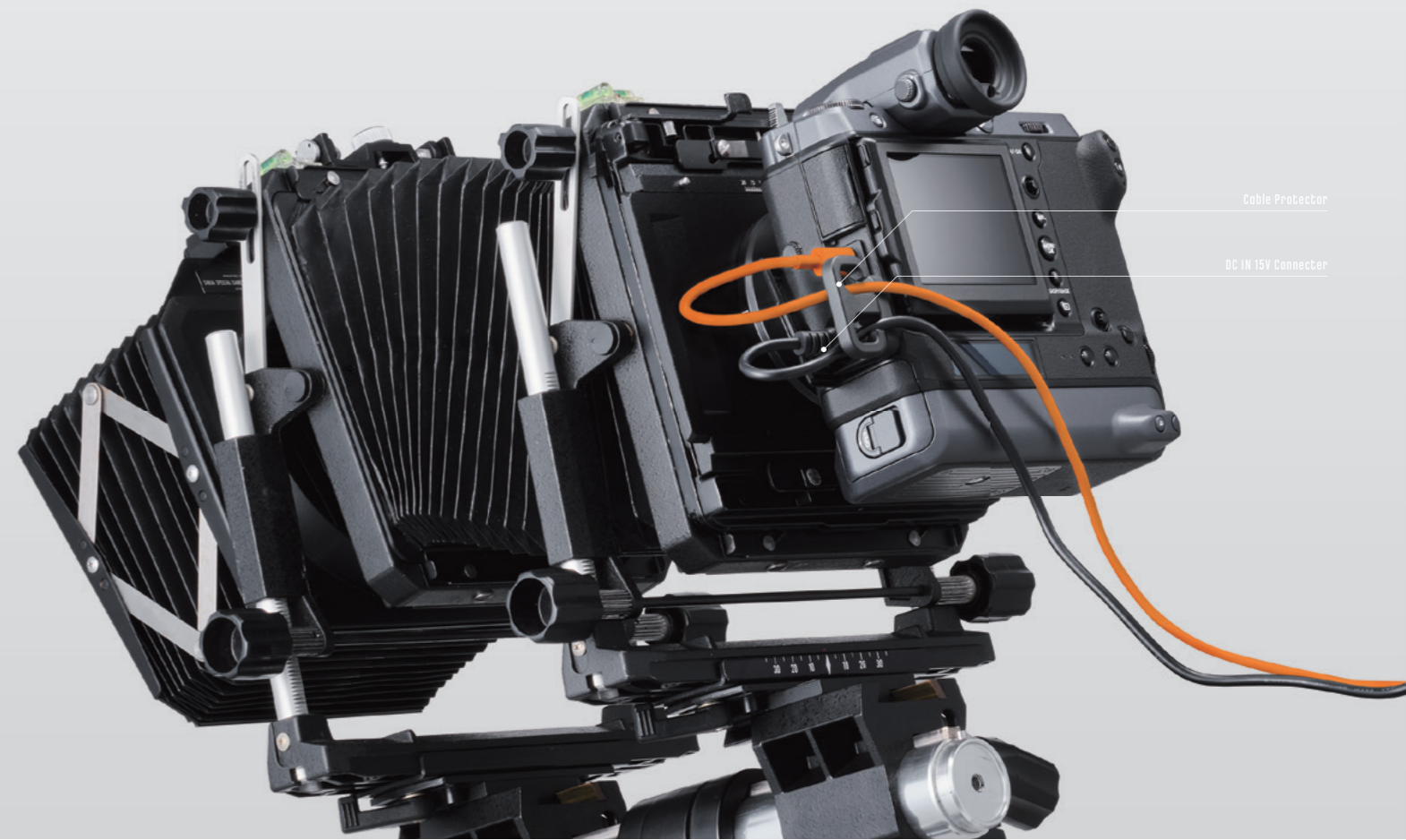

Cable Protector

DC IN 15V Connector

FLASH SHOOTING

EF-X500 Optional

Flash sync speed is up to 1/125sec. When using the optional EF-X500 or compatible third-party studio flash (which supports FP mode) flash sync can be as fast as 1/4000sec. (the maximum shutter speed possible with the mechanical shutter). The camera also caters to a variety of flash settings including multiple flash lighting.

- Guide Number** Approx. 50 (ISO100-m) / 164 (ISO100-Ft)
- Flash Coverage** 24mm-105mm (35mm Format equivalent), Auto Zoom Function, Approx. 20mm (35mm Format equivalent) when using the Wide Panel
- Bounce** 90°up, 10°down, 135°left and 180°right
- Color Temperature** Approx. 5600K (at Full Output)
- FP (High Speed Flash Sync) Mode** Supported
- Exposure Control System** TTL, Manual, Multi-Flash (Manual)
- TTL Compensation** -5.0EV - +5.0EV at 1/3-step increments
*This setting may not be reflected in some shooting conditions.
- Manual Flash Power** 1/1-1/512 at 1/3-step increments
*Flash settings become slightly restricted in the FP mode.
- Multi-Flash Power** 1/4-1/512 at 1/3-step increments
- Firing Interval** (at Full Power and Full Charge) Approx. 2.5 seconds (Nickel-Hydrogen Battery)
- Number of Flashes** (at Full Power and Full Charge) Approx. 170 times (Nickel-Hydrogen Battery)
- Wireless Multi-Flash System** Communication Method Optical Transmission
- Operation Modes** Master (TTL / Manual / Multi-Flash / OFF)
Slave (TTL / Manual / Multi-Flash / OFF)
- Communication Channels** Ch1 - 4
- Slave Unit Groups** Up to 3 Groups (A / B / C)
- Power Source** Four AA Batteries (LR6, or Ni-MH)
- External Power Source** Battery Pack EF-BP1 (Optional)
- Dimensions / Weight** Approx. 124.0mm (H) × 67.2mm (W) × 107.3mm (D)
Approx. 380g (Excluding Batteries)

MOUNT ADAPTER

H MOUNT ADAPTER G Optional

Enables compatibility with H Mount lenses, including SUPER EBC FUJINON HC lenses for GX645AF (discontinued), to be attached to the G Mount. It supports lens shutter operations and aperture priority AE. Focusing is manual only, but the mount features electronic contacts to generate and record lens correction data for individual lenses. A detachable tripod collar foot is included.

- Compatible Lens** H Mount Lens
- Exposure Mode** Aperture Priority AE (A) and Manual
- Shutter Select** Camera Body Focal Plane Shutter / Leaf Shutter in Lens
- Focus Mode** Manual Focus Only
- Operation Parts** Fn button (Shutter Select), Mount Release Lever, Detachable Tripod collar Foot



VIEW CAMERA ADAPTER

VIEW CAMERA ADAPTER G Optional

Allows you to use a 4x5 view camera on the G Mount in conjunction with old large format FUJINON lenses. This allows you to take advantage of a view camera's characteristic tilt and shift functions while using the focal-plane shutter in the camera body.

- Compatible Body** International Standard 4×5 Camera*
- Operation Parts** ±20mm Horizontal Shift Slider (5.0mm step)
- Mount Rotatable** 0° / 90° / 180° / 270°

*Depending on body shape, this adapter may not be attached.



TERMINAL

InterFace For External Connections

The GFX100's terminal for external connections features a USB-C port for high speed image transfer, a micro-HDMI port to connect to an external monitor, a microphone input, a headphone jack and a remote shutter release connection. The camera can be powered and charged by connecting an AC power adapter (optional) to the power plug input connector or a USB Power Delivery device to the USB-C port. The camera comes with a cable protector for holding cables in place.

- Digital InterFace** USB Type-C (USB3.2 Gen1 x1)
- HDMI Output** HDMI Micro Connector (Type D)
- DC IN 15V Connector**
*Compatible with AC-15V (Optional) Only
- Remote Release Connector** ø2.5mm
*Connectable with Remote Release RR-100 (Optional)
- Microphone Connector** ø3.5mm, Stereo Mini Connector
- Headphone Connector** ø3.5mm, Stereo Mini Connector
- Others** Hot Shoe, Synchronized Terminal





WORKFLOW

Software Support

You can set up a photographic workflow including tethering, RAW processing preview, RAW development and image checking by installing compatible software to your computer. This can be achieved using FUJIFILM's own software as well as traditional photo processing applications. Tethered shooting can be achieved by connecting the camera to your computer with a USB cable or setting up a WiFi connection via wireless devices. The IEEE802.11ac has been added to a list of supported wireless protocols to enable data transfer on a 5GHz network.

CAPTURE ONE PRO / CAPTURE ONE PRO FUJIFILM Optional

Capture One Pro FUJIFILM is a photographic workflow application*1 specifically designed for the GFX and X Series cameras and utilizing the diverse and powerful editing functions of Capture One Pro. It is available for purchase from Phase One's website. The software offers a cataloging function to manage your individual images or sessions of shooting, whilst enabling fast and precise control throughout your workflow from tethered shooting to RAW processing. The Capture Pilot function lets you view and check images you have taken wirelessly on a tablet device, etc.



*1 See Phase One's website for details of compatible cameras.

FUJIFILM X ACQUIRE Free Download *2

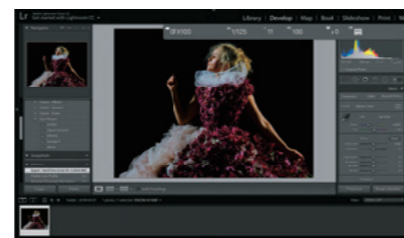

*2 Available as a Free download from the FUJIFILM website.

FUJIFILM TETHER SHOOTING PLUG-IN PRO + ADOBE® PHOTOSHOP® LIGHTROOM® CLASSIC CC Optional



FUJIFILM X RAW STUDIO

Free Download *3

This unique RAW development software from FUJIFILM connects a computer installed with X RAW STUDIO and camera via USB cable. The processor in the camera can be used to process RAW files, including large batches of images, without any limitations or delays from your computer. Offering an optimized environment for the GFX100, you can get complete image quality including tone, color reproduction, and Film Simulations.



*3 Available as Free download from the FUJIFILM website.

CAPTURE ONE EXPRESS FUJIFILM

Free Download *4

This software supports RAW conversion of files from the GFX and X Series range of cameras*5. The software uses a unique cataloguing format to manage pictures, enabling fast processing of individual images regardless of the quantity or size. FUJIFILM's unique Film Simulation modes can be applied during RAW conversion so that you can add an artistic flair or traditional film look and feel. This RAW conversion software is available as a free download from Phase One website.



*4 Available as Free download from the Phase One website.

*5 See Phase One website for details of supported cameras.

SYSTEM
GFX System

The GFX100 is the flagship large CMOS sensor mirrorless digital camera from FUJIFILM. The camera system is fully capable of exceeding the needs of professional photographers and videographers in a variety of shooting situations.

*See FUJIFILM website for detail information
<https://fujifilm.jp/personal/digitalcamera/gfx/>



STEREO MICROPHONE
MIC-ST1

CLIP ON FLASH
EF-X500
Add more

EVF TILT ADAPTER
EVF-TL1

EVF
Included

HOT SHOE COVER
Included

EYE CUP
EC-GFX
EC-XT S
EC-XT M
EC-XT L
EC-XH W

PROTECTOR FILTER
PRF-62
PRF-82
Add more

INTERCHANGEABLE LENS
GF32-64mmF4 R LM WR
GF63mmF2.8 R WR
Add more
Refer to P27 - 28

CABLE PROTECTOR
Included

REMOTE RELEASE
RR-100
Add more

TELECONVERTER
GF1.4X TC WR

MACRO EXTENSION TUBE
MCEX-18G WR
MCEX-45G WR

MOUNT ADAPTER
H MOUNT ADAPTER G

TOSHIBA
EXCERIA PRO
128GB
128GB
M.VNR08

FUJIFILM
BATTERY CHARGER
BC-T125
Included

FUJIFILM
BATTERY
NP-T125
Included

BATTERY
NP-T125
Included

AC POWER ADAPTER
AC-15V

SHOULDER STRAP
Included

VIEW CAMERA ADAPTER
VIEW CAMERA ADAPTER G



VICTOR
LIU
@FX100
@F23mmF4 R LM WR
1/4s
F11
ISO100

GFX 100 SPECIFICATION SHEET

Model name	FUJIFILM GFX100	
Number of effective pixels	102 million pixels	
Image sensor	43.8mm×32.9mm Bayer array with primary color filter	
Sensor Cleaning System	Ultra Sonic Vibration	
Storage media	SD Card (-2GB) / SDHC Card (-32GB) / SDXC Card (-512GB) UHS-I / UHS-II / Video Speed Class V90 **	
File format	JPEG: Exif Ver.2.3)* ² RAW: 14bit / 16bit RAW (RAF original format) RAW+JPEG: 8-bit /16-bit (10-bit output in 16bit file) TIFF: In-camera Raw Conversion Only	
Number of recorded pixels	[L] <4:3> 11648×8736 <3:2> 11648×7768 <16:9> 11648×6552 <1:1> 8736×8736 <65:24> 11648×4304 <5:4> 10928×8736 <7:6> 10192×8736 [M] <4:3> 8256×6192 <3:2> 8256×5504 <16:9> 8256×4640 <1:1> 6192×6192 <65:24> 8256×3048 <5:4> 7744×6192 <7:6> 7232×6192 [S] <4:3> 4000×3000 <3:2> 4000×2664 <16:9> 4000×2248 <1:1> 2992×2992 <65:24> 4000×1480 <5:4> 3744×3000 <7:6> 3504×3000	
Lens Mount	FUJIFILM G mount	
Sensitivity	Still Image Standard Output	AUTO1/AUTO2/AUTO3 (up to ISO12800) / ISO100-12800 (1/3 step)
	Still Image Extended Output	ISO50 / 25600 / 51200 / 102400
	Movie Standard Output	AUTO / ISO200-12800
	Extended Output	ISO25600
Exposure control	TTL 256-zone metering, Multi / Spot / Average / Center Weighted	
Exposure mode	P (Program AE) / A (Aperture Priority AE) / S (Shutter Speed Priority AE) / M (Manual Exposure)	
Exposure compensation	Still Image	-5.0EV - +5.0EV 1/3EV step
	Movie	-2.0EV - +2.0EV 1/3EV step
Image Stabilizer	Mechanism	Image sensor shift mechanism with 5-axis compensation
	Compensation Effect	5.5 stops (based on CIPA standard). Pitch/yaw shake only. With GF63mmF2.8 R WR lens mounted.
Shutter type	Focal Plane Shutter	
Shutter speed	Mechanical Shutter	P mode: 4sec. to 1/4000sec. A mode: 30sec. to 1/4000sec. S/M mode: 60min. to 1/4000sec. Bulb mode: up to 60min.
	Electronic Shutter**3	P mode: 4sec. to 1/16000sec. A mode: 30sec. to 1/16000sec. S/M mode: 60min. to 1/16000sec. Bulb mode: up to 60min.
	Electronic Front Curtain Shutter**4	P mode: 4sec. to 1/4000sec. A mode: 30sec. to 1/4000sec. S/M mode: 60min. to 1/4000sec. Bulb mode: up to 60min.
	Mechanical + Electronic Shutter**3	P mode: 4sec. to 1/16000sec. A mode: 30sec. to 1/16000sec. S/M mode: 60min. to 1/16000sec. Bulb mode: up to 60min.
	Electronic Front Curtain Shutter + Electronic Shutter**3**4	P mode: 4sec. to 1/16000sec. A mode: 30sec. to 1/16000sec. S/M mode: 60min. to 1/16000sec. Bulb mode: up to 60min.
	Movie	1/4000sec.-1/4sec*. *Cannot choose slower shutter speed than framerate with LongGOP recording.
	Synchronized shutter speed for flash	1/125sec. or slower
Continuous shooting	CH Approx. 5.0fps (JPEG: 41 Frames Lossless compression RAW: 14 Frames Uncompressed RAW: 13 Frames) CL Approx. 2.0fps (JPEG: Endless Lossless compression RAW: 20 Frames Uncompressed RAW: 15 Frames) *When Using the Electronic Shutter CH continuous shooting speed drops to approx. 2.9fps. *Electronic Front Curtain Shutter support CL only. *Recordable frame depends on recording media. *Speed of continuous shooting depends on shooting environment and shooting frames.	
Auto bracketing	AE Bracketing (Frames: -2, -3, +3, +2, ±9, ±7, ±5, ±3 Step: 1/3EV, 2/3EV, 1EV, 4/3EV, 5/3EV, 2EV, 7/3EV, 8/3EV, 3EV) Film Simulation bracketing (Any 3 types of film simulation selectable) Dynamic Range Bracketing (100%, 200%, 400%) ISO sensitivity Bracketing (±1/3EV, ±2/3EV, ±1EV) White Balance Bracketing (±1, ±2, ±3) Focus Bracketing (Frames: 1-999, Step: 1-10, Interval: 0-10s)	
Focus	Mode	Single AF / Continuous AF / MF
	Type	Intelligent Hybrid AF (TTL contrast AF / TTL phase detection AF)
	AF frame selection	Single point AF: EVF / LCD: 13×9 / 25×17 (Changeable size of AF frame) Zone AF: 3×3 / 5×5 / 7×7 from 117 areas on 13×9 grid Wide/Tracking AF: (up to 18 area) * AF-S: Wide / AF-C: Tracking All
White balance	Automatic Scene recognition / Custom1-3 / Color temperature selection (2500K-10000K) / Preset: Fine, Shade, Fluorescent light (Daylight), Fluorescent light (Warm White), Fluorescent light (Cool White), Incandescent light, Underwater	
Self-timer	10sec. / 2sec.	
Interval timer Shooting	Yes (Setting : Interval, Number of shots, Starting time, Interval timer shooting exposure smoothing)	
Flash modes *When EF-X500 is set	SYNC. MODE	1ST CURTAIN / 2ND CURTAIN / AUTO FP(HSS)
	FLASH MODE	TTL (TTL AUTO (P mode) / STANDARD / SLOW SYNC.) / MANUAL / MULTI / OFF
Hot shoe	Yes (Dedicated TTL Flash compatible)	
Viewfinder	0.5 inch Approx. 5.76 million dots OLED Color Viewfinder Coverage of Viewing Area vs. Capturing Area: Approx. 100% Eyepoint: Approx. 23mm (from the Rear End of the Camera's Eyepiece) Diopter Adjustment: -4 - +2m ⁻¹ Magnification: 0.86× with 50mm Lens (35mm Equivalent) at infinity and Diopter set to -1.0m ⁻¹ Diagonal Angle of View: Approx. 41° (Horizontal Angle of View: Approx. 33°) Built-in Eye Sensor	
LCD monitor	3.2 inch, Aspect Ratio 4:3, Approx. 2.36 million dots Tilt-Type(Three Direction), Touch Screen Color LCD Monitor (Approx. 100% Coverage)	
Touch Screen Mode	Shooting Mode	Touch AF, Focus Area, OFF Double Tap ON/OFF Setting Touch Function ON/OFF Setting
	Playback Mode	Swipe, Zoom, Pinch-in / Pinch-out, Double-tap, Drag (ON/OFF Selectable)
Sub LCD monitor	1.80 inch, Aspect Ratio 4:3, 303×230-dot Monochrome LCD Monitor	
Rear sub monitor	2.05 inch, Aspect Ratio 4:1, 256×64-dot Monochrome OLED Monitor	

Movie recording	File format	MOV (MPEG-4 AVC / H.264, HEVC / H.265, Audio : Linear PCM / Stereo sound 24bit / 48KHz sampling)
	Movie compression	All Intra / Long-GOP *All Intra can be used with following settings. DCI4K / 4K 29.97p / 25p / 24p / 23.98p 400Mbps Full HD(2048×1080) / Full HD (1920×1080) 59.94p / 50p / 29.97p / 25p / 24p / 23.98p 200Mbps
	File size / Frame rate / Recording time	[DCI4K (4096×2160)] 29.97p / 25p / 24p / 23.98p 400Mbps / 200Mbps / 100Mbps up to Approx. 60min. [4K (3840×2160)] 29.97p / 25p / 24p / 23.98p 400Mbps / 200Mbps / 100Mbps up to Approx. 60min. [Full HD (2048×1080)] 29.97p / 25p / 24p / 23.98p 200Mbps / 100Mbps / 50Mbps up to Approx. 80min. [Full HD (1920×1080)] 29.97p / 25p / 24p / 23.98p 200Mbps / 100Mbps / 50Mbps up to Approx. 80min. * For recording movies, use a SD memory card with UHS Speed Class 3 or higher. * For recording movies in 400Mbps, use a SD memory card with Video Speed Class 60 or higher. * Recording movies in 400Mbps can be done with DCI4K / 4K 29.97p / 25p / 24p / 23.98p.
Film Simulation mode	16 modes (PROVIA / Standard, Velvia / Vivid, ASTIA / Soft, Classic Chrome, PRO Neg.Hi, PRO Neg.Std, ETERNA / CINEMA, Black&White, Black&White+Ye Filter, Black&White+R Filter, Black&White+Gfilter, Sepia, ACROS, ACROS+Ye Filter, ACROS+R Filter, ACROS+G Filter)	
B & W ADJ. (Warm/Cool)	-9 - +9 *When ACROS or Black&White is selected.	
Grain Effect	STRONG, WEAK, OFF	
Color Chrome Effect	STRONG, WEAK, OFF	
Smooth Skin Effect	STRONG, WEAK, OFF	
Dynamic range setting	AUTO, 100%, 200%, 400%	
Photography functions	D range priority, Highlight tone, Shadow tone, Color, Sharpness, Noise reduction, Long exposure NR, Lens Modulation Optimizer, Color space, Pixel mapping, Select custom setting, Edit/Save custom setting, AF-C custom setting, Store AF mode by orientation, AF point display, Pre-AF, AF Illuminator, Face/Eye detection AF, AF+MF, MF assist(Digital Split Image, Digital Microprism, Focus peak highlight), Focus check, Interlock spot AE & focus area, Instant AF setting (AF-S/AF-C), Depth-of-field scale, Release/Focus priority, Touch screen mode, Flicker reduction, Mount adapter setting, 35mm Format Mode, Red eye removal, RGB Histogram, Highlight alert, Electronic level, Preview depth of field, AE lock, AF lock, AF-ON, AWB lock, Multiple exposure	
Movie functions	Interframe NR, F-Log/HLG recording, Peripheral light correction, Movie AF mode, 4K movie output, Full HD movie output, HDMI output info display, 4K HDMI standby quality, HDMI rec control, Zebra setting, Zebra level, Audio setting, Time code setting, Tally light, Movie silent control	
Playback functions	Switch slot, RAW conversion, Erase, Erase selected frames, Simultaneous delete(Raw Slot1/JPG Slot2), Crop, Resize, Protect, Image rotate, Red eye removal, Voice memo setting, Copy, Photobook assist, Multi-frame playback (with micro thumbnail), Favorites, RGB histogram, Highlight alert	
Wireless transmitter	Standard	IEEE802.11a/b/g/n/ac (standard wireless protocol)
	Encryption	WEP/WPA/WPA2 mixed mode
	Access mode	Infrastructure
Bluetooth®	Standards	Bluetooth Ver. 4.2(Bluetooth low energy)
	Operating frequency	2402 - 2480MHz(Center frequency)
Wireless function	Geotagging, Image transfer (Individual image/Selected multiple images), View & Obtain Images, instax Printer Print, Pairing registration, Delete pairing registration, Bluetooth ON/OFF setting, Auto image transfer, Smartphone Sync. Setting, Wireless com. frequency setting	
Other functions	Exif Print, Date/Time, Time difference, 35 Languages, My menu setting, Sensor cleaning, Battery age, Regulatory, Sound set-up, EVF brightness, EVF color, EVF color adjustment, LCD brightness, LCD color, LCD color adjustment, Image disp, Auto rotate displays, Preview exp./WB in manual mode, Natural live view, Framing guideline, Auto rotate PB, Focus scale units, Dual display setting, Disp. custom setting, Large indicators mode(EVF/LCD), Large indicators disp. setting, Information contrast adj. Sub monitor setting, Rear sub monitor setting, Sub monitor background color, Rear sub monitor brightness, Focus lever setting, Edit/Save Quick menu, Function(Fn) setting, Command dial setting, Shutter AF, Shutter AE, Shoot without lens, Shoot without card, Focus ring, Focus ring operation, AE/AF-Lock mode, AWB-Lock mode, Expo. Comp. button setting, Touch screen setting, Lock, Auto power off, Performance, Shooting stand by mode, Auto power save, Frame No., Save org image, Edit file name, Card slot setting, Select slot, Select Folder and Create Folder, Copyright Info	
Terminal	Digital interface	USB Type-C (USB3.2 Gen1x1)
	HDMI output	HDMI Micro connector (Type D)
	Others	ø3.5mm, stereo mini connector (Microphone) ø3.5mm, stereo mini connector (Headphone) ø2.5mm, Remote Release Connector DC IN 15V Connector *Compatible with AC-15V (Optional) Only Hot shoe Synchronized terminal
	Power supply	NP-T125 (x2) Li-ion battery (included)
	Battery life for still images*5	Approx. 800 frames When GF63mmF2.8 R WR is set. (2 batteries installed, Auto power save ON)
	Actual battery life of movie capture*5	[4K] Approx. 100min. [Full HD] Approx. 150min. *Face detection is set to OFF
	Continuance battery life of movie capture*5	[4K] Approx. 170min. [Full HD] Approx. 240min. *Face detection is set to OFF
USB power supply	Support USB PD(Power Delivery) power source to supply or rapidly recharge battery (USB PD Rev2.0 ver1.3)	
Dimensions	[Including EVF] 156.2mm (W) × 163.6mm (H) × 102.9mm (D) / 6.15in. (W) × 6.44in. (H) × 4.05in. (D) (Minimum Depth : 48.9mm / 1.93in.) [Excluding EVF] 156.2mm (W) × 144.0mm (H) × 75.1mm (D) / 6.15in. (W) × 5.67in. (H) × 2.96in. (D) (Minimum Depth : 48.9mm / 1.93in.)	
Weight	Approx. 1,400g / 49.4oz. (including EVF, battery x2 and memory card) Approx. 1,320g / 46.6oz. (including battery x2 and memory card) Approx. 1,155g / 40.7oz. (excluding accessories, battery and memory card)	
Operating environment	Operating Temperature	-10°C - 40°C (+14°F - +104°F)
	Operating Humidity	10% - 80% (no condensation)
Starting up period	Approx. 0.4sec. *FUJIFILM Research	
Accessories included	Li-ion batteries NP-T125 (x2), Battery charger BC-T125, Plug adapter, Interchangeable electronic viewfinder EVF-GFX2, Body cap, Metal strap clips (x2), Clip attaching tool, Protective covers (x2), Shoulder strap, Cable protector, Hot shoe cover (Body/EVF), Connector cover (EVF), Sync terminal cover, Owner's manual	

*1 Please see the FUJIFILM website to check memory card compatibility.

*2 Exif 2.3 is a digital camera file format that contains a variety of shooting information for optimal printing.

*3 The Electronic Shutter may not be suitable for fast-moving objects or handheld shooting. Flash can not be used.

*4 When using the electronic front curtain shutter, the continuous shooting supports CL only and using high speed shutter, the shutter switches to mechanical shutter. (Faster than 1/1250sec. to 1/4000sec.)

*5 Approximate number of frames or movie recording time that can be taken with a fully-charged based on CIPA Standard.

