

FCR PRIMA II

Enhanced Processing Capacity — leads to smoother operation





With the launch of the first FCR (Fuji Computed Radiography) product in 1983, we have brought "DIGITAL" X-ray diagnostics to the world of analog diagnostics. Since then, our products have always been at the forefront of digital imaging and have contributed to improving the efficiency of diagnostic imaging and the quality of medical care. A new stage in the history of X-ray diagnostics has been marked with the announcement of our FCR PRIMA II. We are confident that this product will further enhance your diagnostic needs.

Only a pioneer can achieve such a thing
— Fujifilm's digital imaging system



Achievement

Since the launching of our first FCR product in 1983, we have been striving to develop the FCR technology further and to make available a wide range of products. Our superb technology and diversified product lineup has gained recognition from medical institutions of all practices and to date over 90,000* digital imaging systems have been installed worldwide.

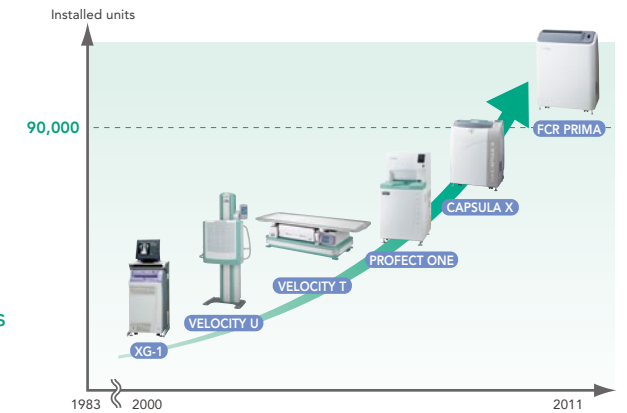

Quality

We have been able to achieve high imaging quality as a result of our long years of research in the technology of medical imaging. The proven high durability and high stability of our products are proof of our high quality.

Unparalleled high quality

The FCR offers over 180 pre-set Exposure Menus. They are optimized to each body part and exposure techniques, and supply you with the best quality image without any extra adjustment. Such excellence has been brought about by extensive joint efforts and collaboration with experienced radiologists for over 25 years.

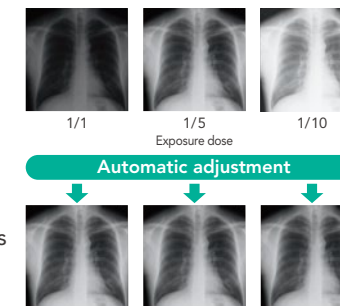

Durability that we can be proud of

The FCR systems have proven to be day-in and day-out reliable, thanks to the well-designed product features and the built-in redundancy that prevents problems before they occur. In working with the FCR, its proven durability will provide you with the maximum uptime for your medical facilities.

Originality

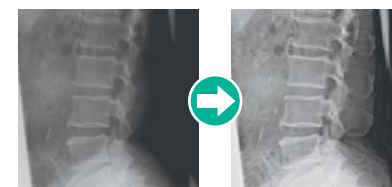

Image Intelligence™ from Fujifilm is an integration of various digital image-processing technologies to enhance the contrast and sharpness of the entire image without any risk of losing the image details. As such, Image Intelligence™ is the result of an ideal combination of Fujifilm's many years of experience in imaging and its ability to create superior hardware and software products.

MFP* Multi-Frequency Processing

Enhances FCR images. All diagnostic scopes will be enhanced except for noise.

*Optional software



FNC Flexible Noise Control

Provides a non-grainy image by mainly isolating and suppressing the noise for the signal.

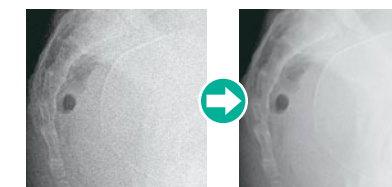

GPR Grid Pattern Removal

Removes the stationary grid patterns thus preventing Moiré from being generated resulting in easier diagnosis.

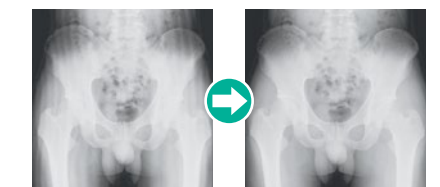

From digitalize to archive, this is Fujifilm's seamless workflow

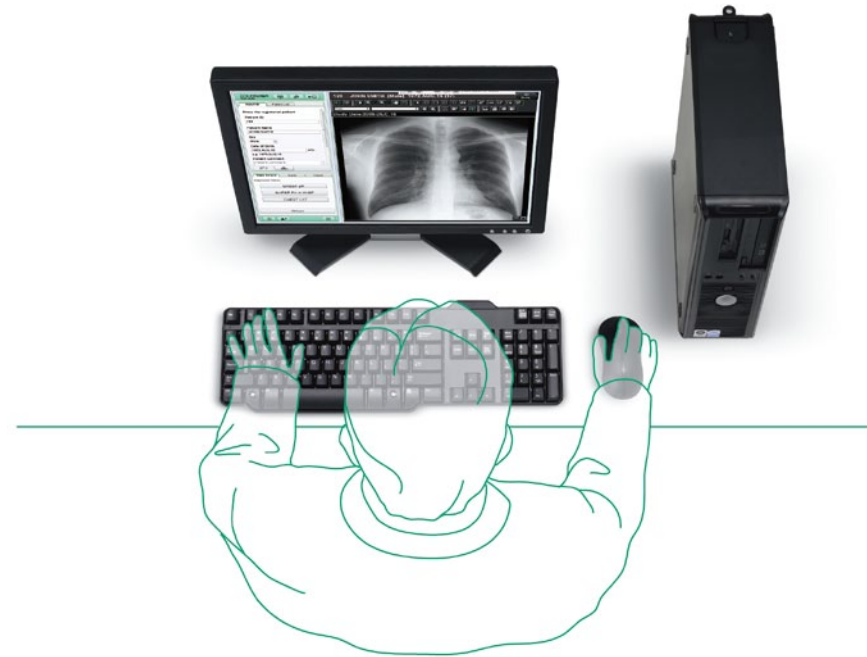
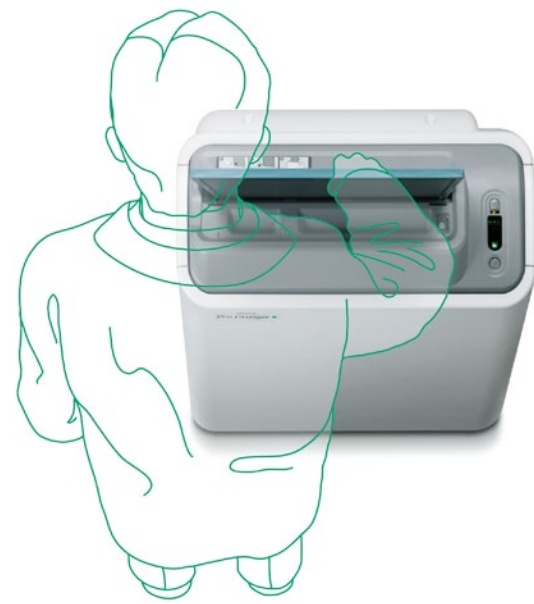

Digitalize

Read

Archive

Compact footprint, only 0.24m²

FCR PRIMA II is one of the most compact and lightweight reader units on the market. The required space is comparatively smaller than other similar table-top systems and can be installed in any open space. Another advantage of this unit is that you don't need a darkroom any longer.



Enhanced IP Processability

The new model FCR PRIMA II now offers enhanced processability with speed of up to 55 IPS/hr., almost double FCR PRIMA's 29 IPS/hr., yet leaving the easy operability and high functionality intact. As a result, the patient handling time at clinics and hospitals is reduced significantly leading to smoother operation and increased patient turnover.

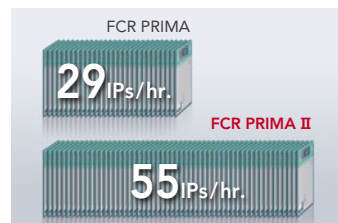

Stable and optimized images

Fujifilm's Image Intelligence™ technology automatically enables stable and optimized high-quality images.

Other features

- Flexible reading in various sizes
- Repeated use of IP

All-in-one workstation

FCR PRIMA Console is a complete image management workstation that is designed for simple and fast patient identification, image acquiring and processing, as well as image viewing, reprocessing, optimizing, and archiving.

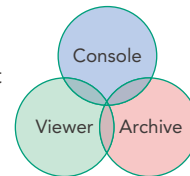

Quick display with simple operation

Easy to use menus that guide your operation from image taking to diagnosis. You can customize the user interface according to your preference such as adding shortcut buttons or removing unneeded ones. Just input the patient information and select the Exposure Menu, then a suitable image processing condition will be automatically applied and the adjusted image will be displayed for diagnosis.



input the patient information and select the Exposure Menu, then a suitable image processing condition will be automatically applied and the adjusted image will be displayed for diagnosis.

Other features

- Limit of access to patient information for security
- Uses a suitable monitor for medical image display

Various diagnostic functions

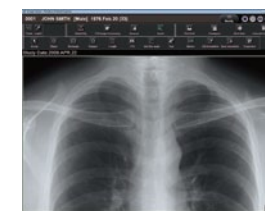

A magnified image

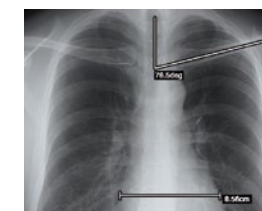

Measurement function

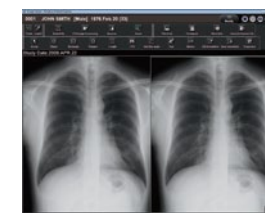

Comparing archived images

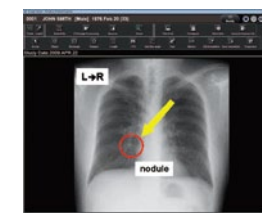

An annotated image

FCR PRIMA Console is a multi-functional unit that has functions to:

- change the magnification of an image
- display the studied images side-by-side
- compare the latest image with the archived images
- measure the length, angle, etc. of the image
- add annotation text, graphic symbols, and electronic markers to an image

Other features

- Preset image processing for more effective diagnosis

Integrated management of image data and patient information

You can register a maximum of 200,000 patient information on the PC. The registered patient information can then be speedily retrieved and displayed by entering the patient name and ID number. Patient information can also be retrieved from a DICOM MWM server*. *Requires an optional software.

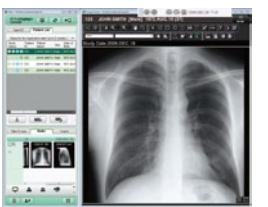

Less storage space

All images are stored in the HDD of the PC. These high-quality images can be copied to a DVD or NAS (Network Attached Storage) as backup. This digital system requires less storage space than an analog imaging system.



The PDI (Portable Data for Imaging) function

By bundling the Simplified DICOM Viewer Software with the patient information onto CD-R or DVD-R, images can be distributed to patients for viewing on their PCs.

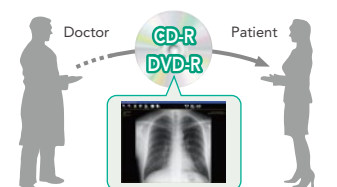

Other features

- Can send images in JPEG format by e-mail
- Can print film through dry imager

FCR PRIMA II Specifications

Standard Components	FCR PRIMA II Image Reader (Model: CR-IR 391RU) AC power cord
Other System Components	IP cassette type CC FCR PRIMA Console, FCRView Dry Imager: DRYPIX PRIMA, DRYPIX 2000, 4000, 7000, Plus
Supplies	Imaging Plate ST-VI: 35 × 43 cm (14" × 17"), 35 × 35 cm (14" × 14"), 10" × 12", 8" × 10", 24 × 30 cm, 18 × 24 cm, 15 × 30 cm (Variation) IP Cassette Type CC: 35 × 43 cm (14" × 17"), 35 × 35 cm (14" × 14"), 10" × 12", 8" × 10", 24 × 30 cm, 18 × 24 cm, 15 × 30 cm (Variation)
Time Required for IP Feed/Load	Min. 66 sec.
Processing Capacity	Up to 55 IPs/hr.
Reading Specification	10 pixels/mm
Time to Start on Display	Min. 33 sec.
Time to Print on DRYPIX PRIMA	Approx. 165 sec. in case of 35 × 43 cm
Number of Stacker	1
Network	10 Base T/100 Base TX
Dimensions (W × D × H)	600 × 400 × 780 mm (24" × 16" × 31")
Weight	70 kg (154 lbs.)
Power Supply Conditions	Single phase 50-60Hz AC100-240V ±10% 5A (max)
Environmental Conditions	Operating Conditions: <ul style="list-style-type: none"> • Temperature: 15-30C • Humidity: 15-80%RH (No dew condensation) • Atmospheric pressure: 750-1060hPa

This equipment is a Class 1 laser product (IEC60825).

Dimensions

Unit: mm (in.)

Imaging Plate ST-VI

35 × 43 cm (14" × 17"),
35 × 35 cm (14" × 14"),
10" × 12", 8" × 10",
24 × 30 cm, 18 × 24 cm,
15 × 30 cm (Variation)



IP Cassette Type CC

35 × 43 cm (14" × 17"),
35 × 35 cm (14" × 14"),
10" × 12", 8" × 10",
24 × 30 cm, 18 × 24 cm,
15 × 30 cm (Variation)



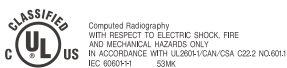

FCR PRIMA II (CR-IR 391RU) CE 0123

FCR PRIMA Console (CR-IR 391CL) CE 0123

Specifications are subject to change without notice.
All brand names or trademarks are the property of their respective owners.
In some countries, regulatory approval may be required to import medical devices.
For the availability of these products, please contact your local sales representatives.

FUJIFILM

FUJIFILM Corporation

26-30, NISHIAZABU 2-CHOME, MINATO-KU, TOKYO 106-8620, JAPAN
<http://www.fujifilm.com/products/medical/>

Ref. No. XB-995E (SK-11-09-F1079-F9711) Printed in Japan ©2011 FUJIFILM Corporation